

Company: L-DEO - Lamont - Doherty Earth Observatory
Vessel: Marcus G. Langseth
Client: Bangs / NSF

Project: MGL1801 -
Area: North Island, New Zealand
Start Date: 6-Jan-18

Vessel Sensor Offsets

Towing Offsets

Towing Configuration

Acoustic Overhead

Gun Array Offsets

Streamer Front End

Streamer Tail End

Streamer Complete

Hydrophone Offsets

Tailbuoy Offsets

Timing



R/V Marcus G. Langseth - Vessel Sensor Offsets

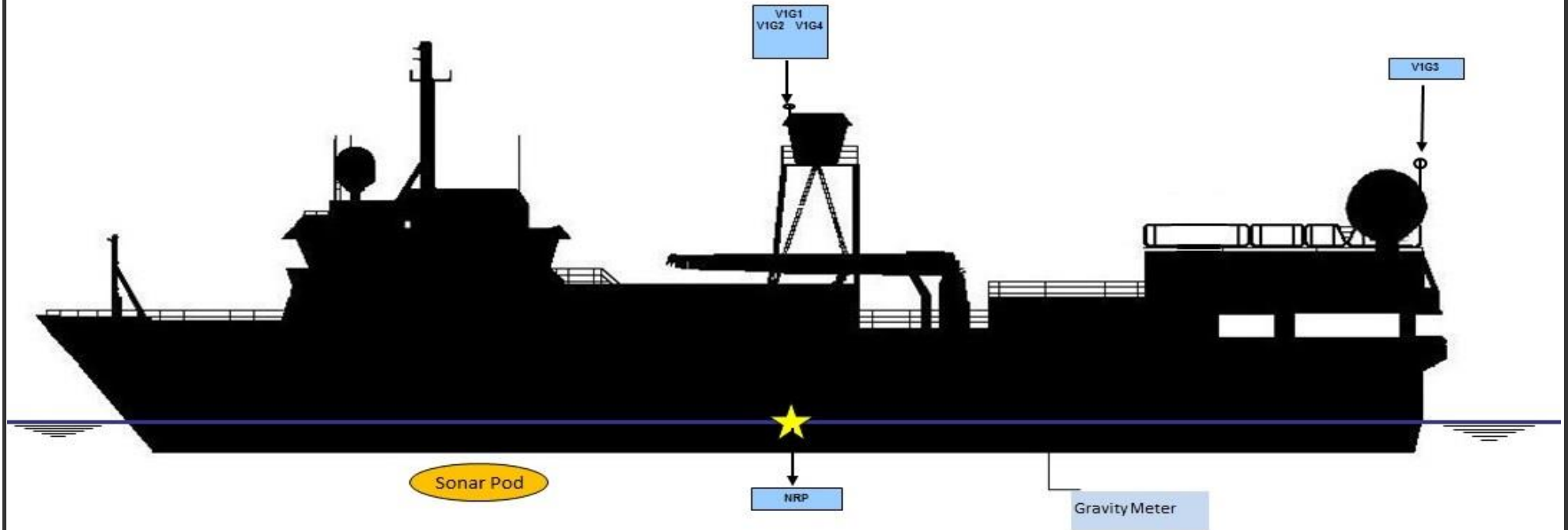

Negative values are above water line
All measurements in meters



		STBD/PORT (X)	FORE/AFT (Y)	UP/DOWN (Z)
NRP	NAVIGATION REFERENCE POINT	0.00	0.00	0.00
V1G1	C-Nav 3050	0.00	0.00	-16.90
V1G2	SeaPath 200	0.00	1.50	-16.90
V1G3	C-Nav 2000	-2.10	-29.20	-14.50
V1G4	Pos MV	-1.30	1.20	-16.90
V1R1	PosNet	-1.30	0.00	-16.90
Sonar Pod	EM122 Knudsen ADCP	0.00	20.20	7.49
	EM122 Center Beam offset (in Spectra)	0.00	13.4	7.49
MRU	Seapath MRU	2.30	14.16	-4.30
BGM	Bell Gravity Meter	0.00	-13.10	1.10

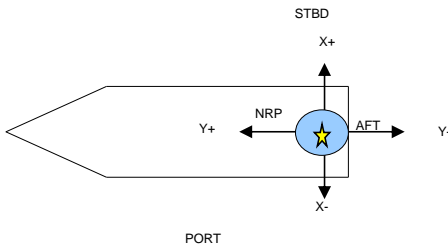

R/V Marcus G. Langseth - Towing Offsets

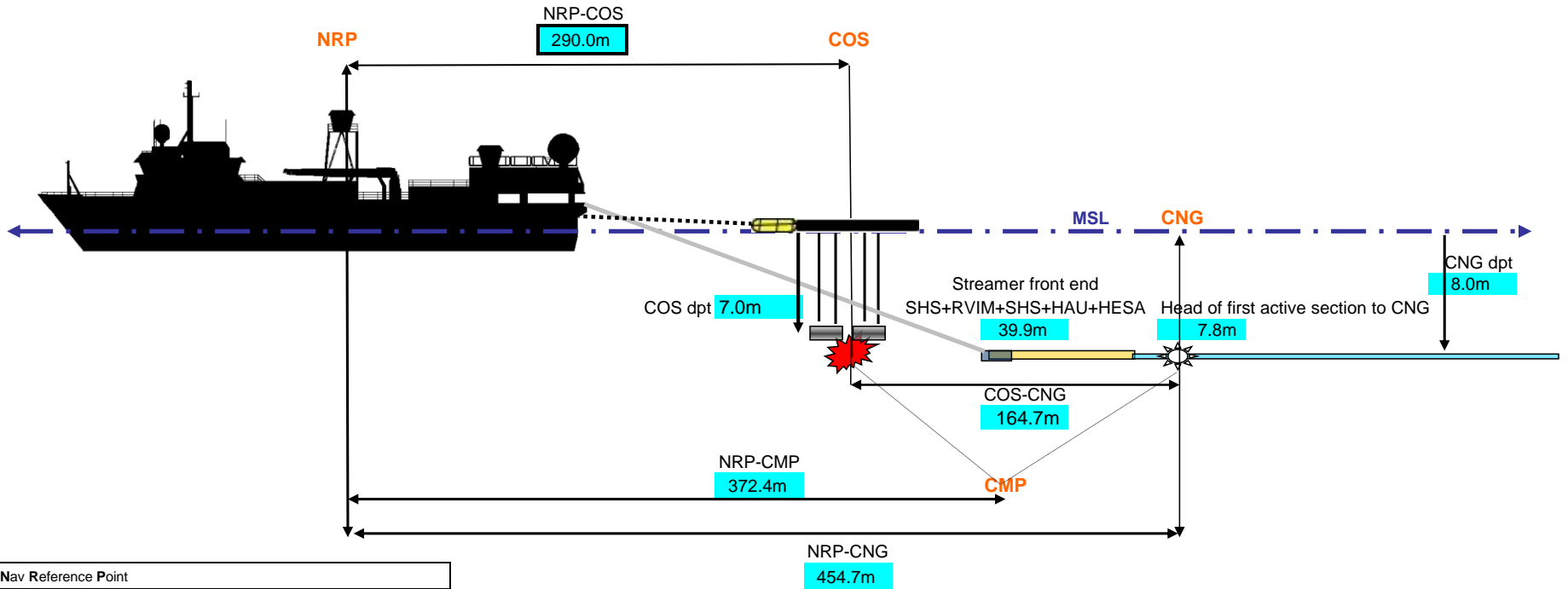

NRP	Nav Reference Point
COS	Centre of Source
CNG	Centre of Near Group Trace # 1 Of S1
CMP	Common Mid-Point
MSL	Mean Sea Level
NRP-Stern	29.5m
NRP-COS	290.0m

All measurements in meters

Cell contents referenced from Config_offsets tab

R/V Marcus G. Langseth - Towing Configuration

Streamer	Lead-in out	Length	Channels	Spacing
1	440.0m	5850.0m	468	12.5m
2	360.0m	5850.0m	468	12.5m
3	360.0m	5850.0m </td <td>468</td> <td>12.5m</td>	468	12.5m
4	440.0m	5850.0m	468	12.5m

Gun Strings Used

Source 1	subarrays 1 and 2	Vol (in^3)	3300
Source 2	subarrays 3 and 4	Vol (in^3)	3300

Wide Tow Rope Deployed

Starboard Wide Tow	445.0m
Port Wide Tow	445.0m

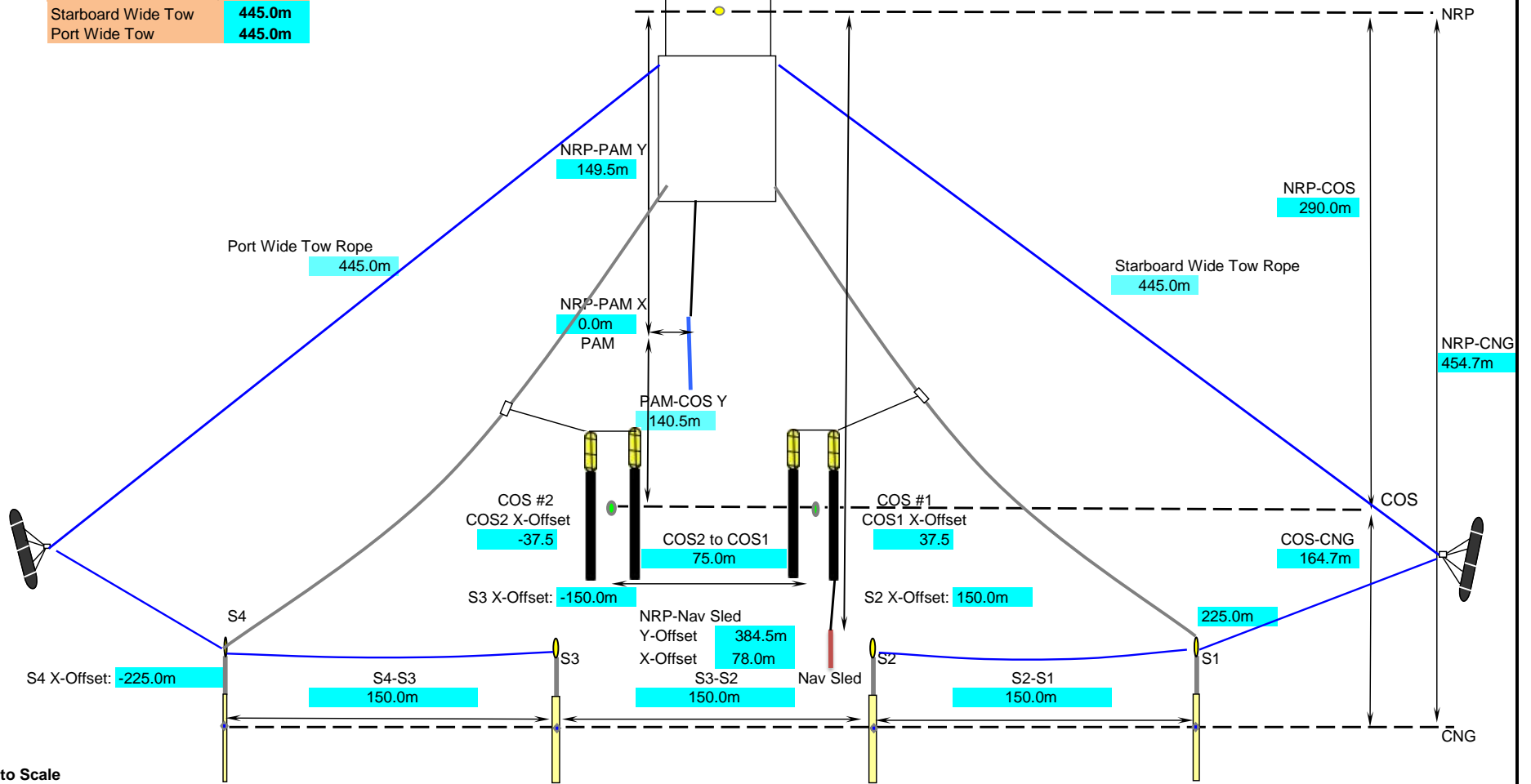

NOT to Scale

Cell contents referenced from Config_offsets tab

R/V Marcus G. Langseth - Acoustic Offsets

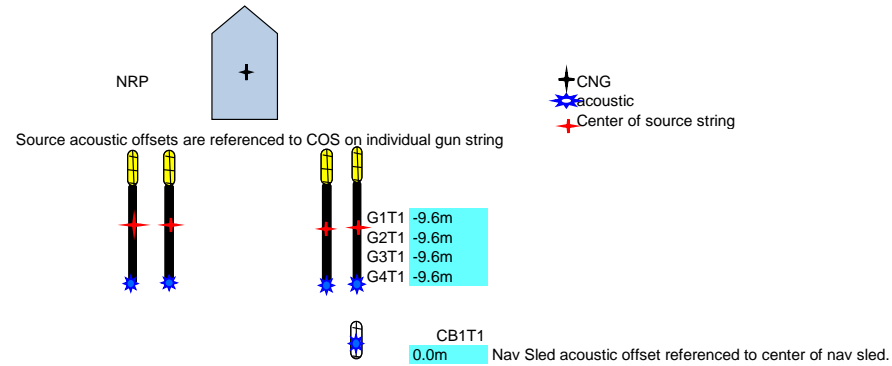

Streamer acoustic offsets are referenced to CNG on individual streamer

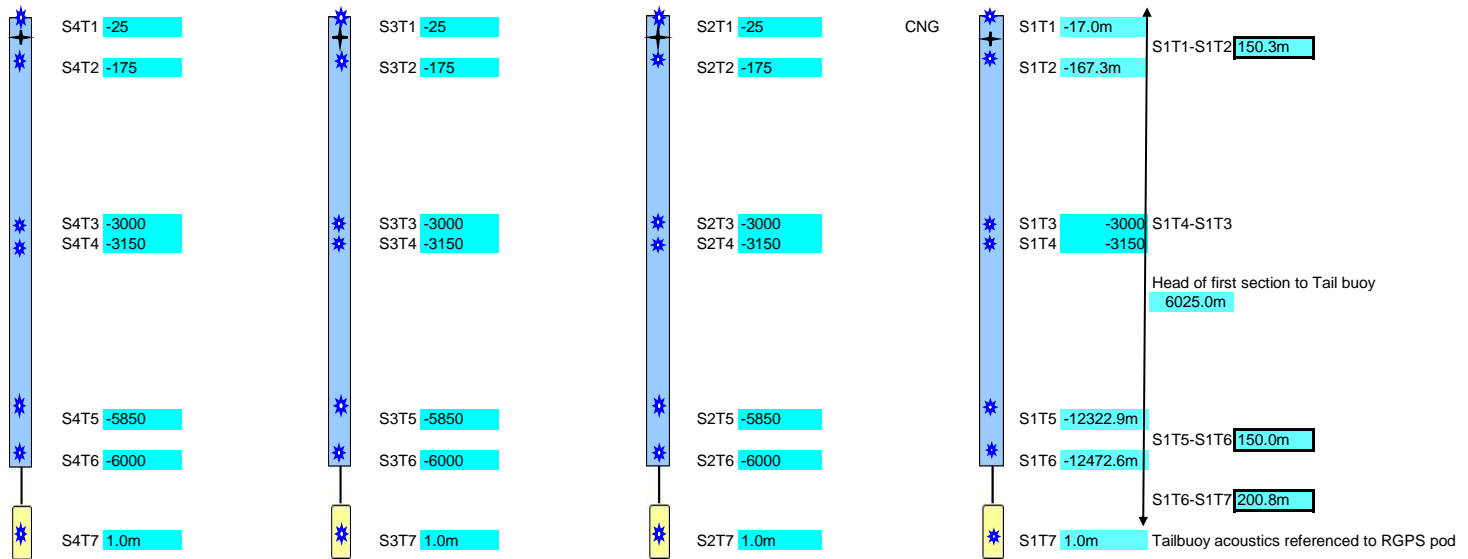

Cell contents referenced from Config_offsets tab

R/V Marcus G. Langseth - Gun Array Offsets

- Pressure Sensor
- Depth Sensor
- Spare Gun

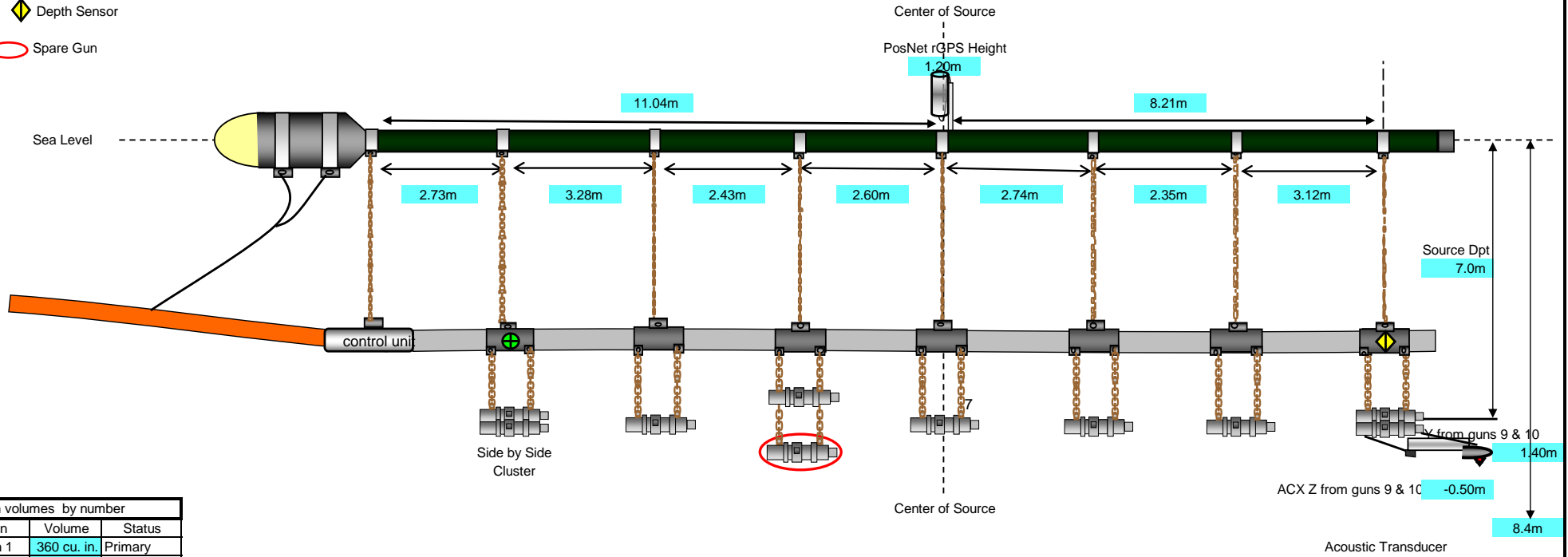

Gun volumes by number		
Gun	Volume	Status
Gun 1	360 cu. in.	Primary
Gun 2	360 cu. in.	Primary
Gun 3	40 cu. in.	Primary & Mitigation
Gun 4	180 cu. in.	Primary
Gun 5	180 cu. in.	Spare
Gun 6	90 cu. in.	Primary
Gun 7	120 cu. in.	Primary
Gun 8	60 cu. in.	Primary
Gun 9	220 cu. in.	Primary
Gun 10	220 cu. in.	Primary

Array total volume (without spares) is 3300 cu. in.
 Guns (1 & 2) in a horizontal cluster, (5 & 6) and (9 & 10) in a vertical cluster
 Gun clusters have 0.75m between guns and hang 0.95m from center of hanger
 Total volume/string (without spare) 1650 cu. in.
 Horizontal Clusters are 1m from gun port to gun port
 Single guns hang from hanger 1.15m
 All gun volumes, numbering, locations, and offsets were inspected and verified by Chief Source Mechanic.
 All measurements in meters
NOTE: drawing not to scale

Cell contents referenced from Config_offsets tab

R/V Marcus G. Langseth - Gun Configuration

DT = Depth Transducer
 ACX = Acoustic
 P = Pressure Sensor - located
 in front of gun's 1 & 2

● Center of Source



Gun Clusters
 Guns 1 & 2 horizontal array
 Guns 4 & 5 vertical array
 Guns 9 & 10 horizontal array

Gun Offsets relative to Center of String

	X	Y
Gun 1	0.50m	8.31m
Gun 2	-0.50m	8.31m
Gun 3	0.00m	5.03m
Gun 4	0.00m	2.60m
Gun 5	0.00m	2.60m
Gun 6	0.00m	0.00m
Gun 7	0.00m	-2.74m
Gun 8	0.00m	-5.09m
Gun 9	0.50m	-8.21m
Gun 10	-0.50m	-8.21m

All measurements in meters

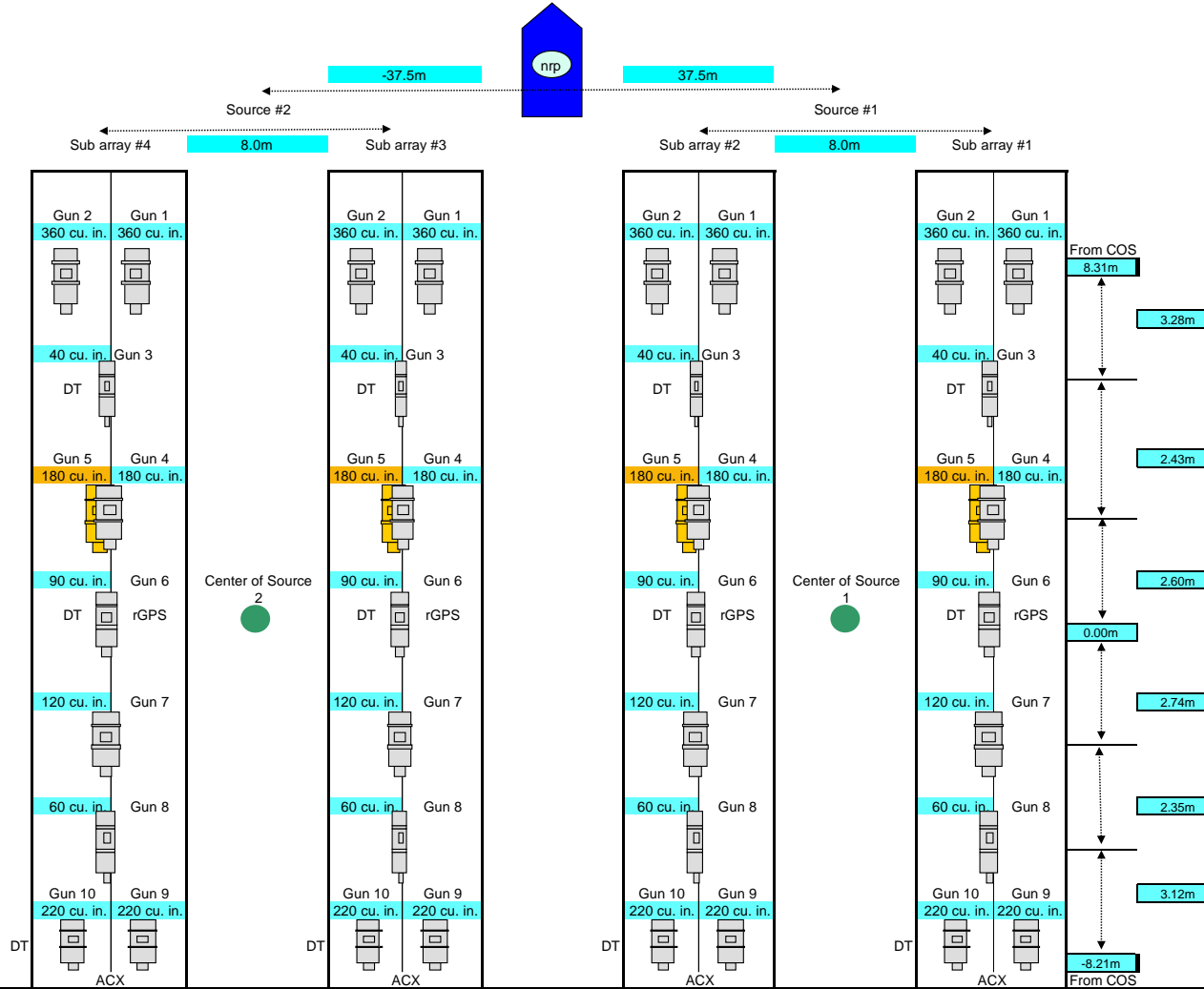

R/V Marcus G. Langseth - Streamer Front End

Total active sections	39
Total Channels	468
Total section length	5850.00m
First to last channel	5837.50m

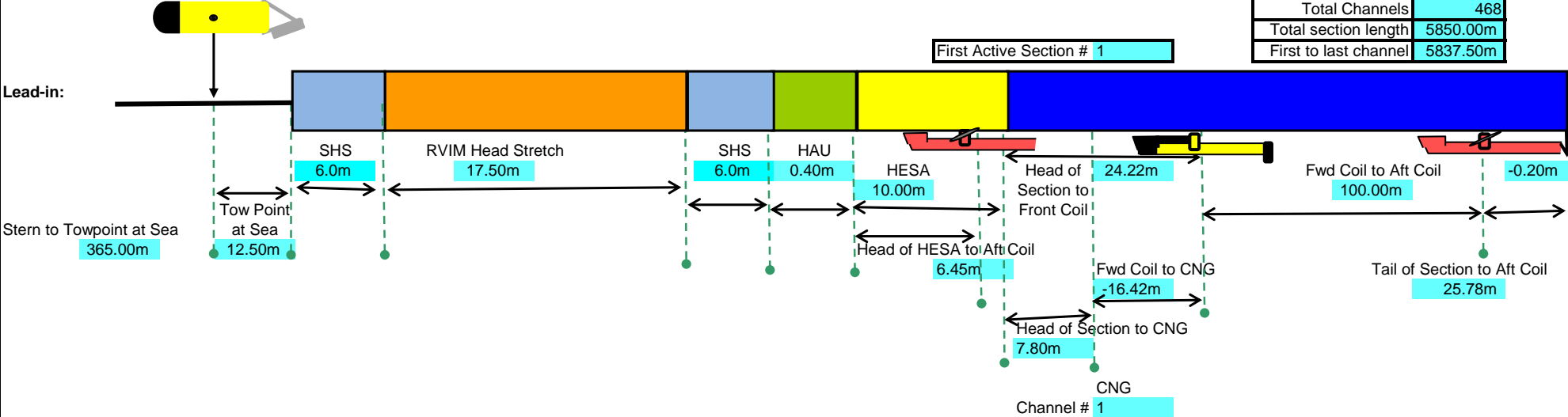

Cell contents referenced from Config_offsets tab

R/V Marcus G. Langseth - Streamer Complete

Total active sections	39
Total Channels	468
Total section length	5850.00m
First to last channel	5837.50m

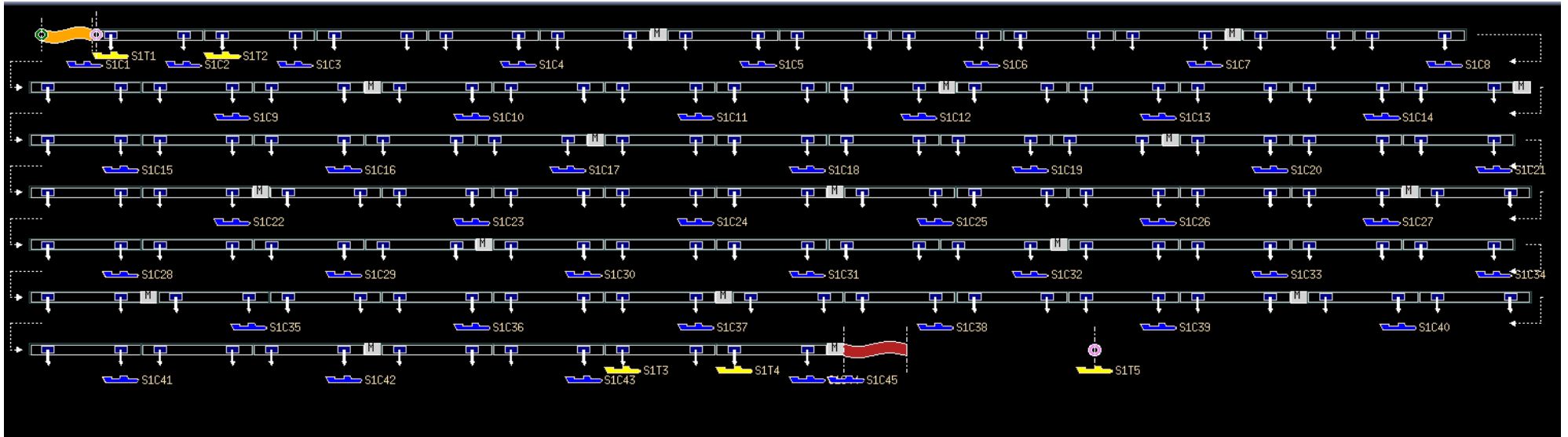

Cell contents referenced from Config_offsets tab

R/V Marcus G. Langseth - Streamer Tail End

Total active sections	39
Total Channels	468
Total section length	5850.00m
First to last channel	5837.50m
CFG to TB RGPS	181.95m

Last Active Section # 39

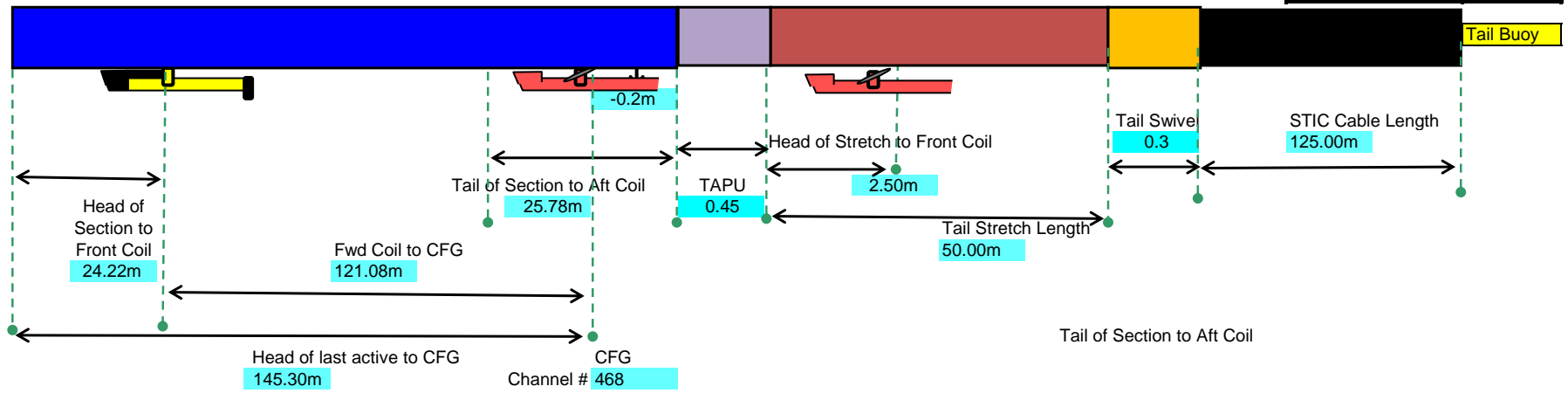

Cell contents referenced from Config_offsets tab

R/V Marcus G. Langseth - Hydrophone Offsets
Sercel 150meter SSAS

Number of SSAS Sections 39
Channels per active section 12
Total channels 468

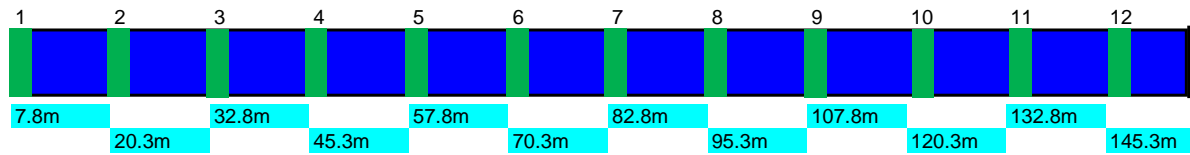
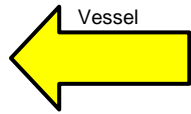

Tail buoy

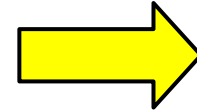

Cell contents referenced from Config_offsets tab

R/V Marcus G. Langseth - Tailbuoy

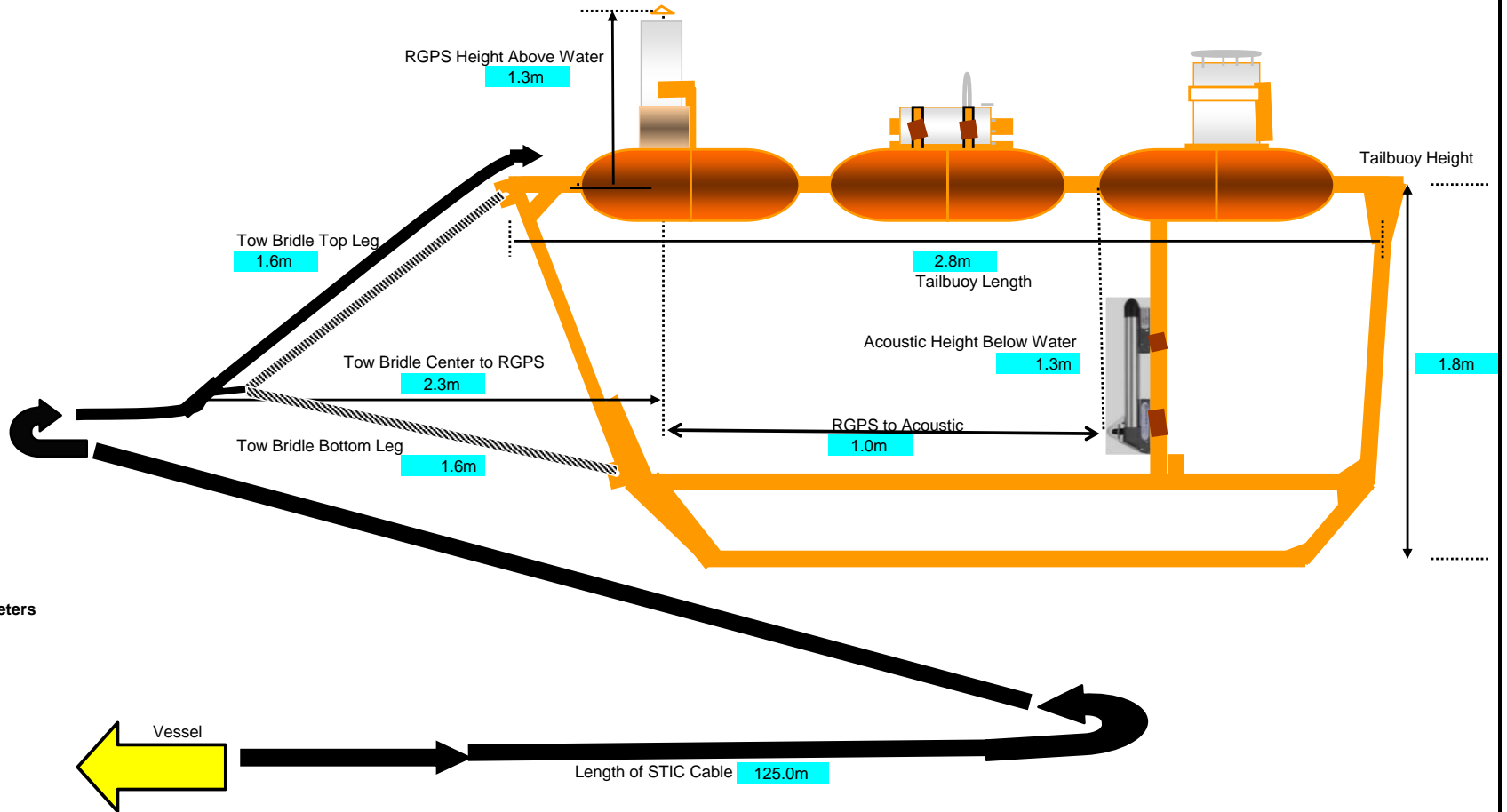

All measurements in meters

Cell contents referenced from Config_offsets tab

