

Company : LDEO - Lamont Doherty Earth Observatory
Vessel : Marcus G.Langseth
Client : NSF

Project : MGL-1408 NSF
Area : Offshore North Carolina
Start Date : 16 September 2014

Vessel Sensor Offsets

Towing Offsets

Towing Configuration

Acoustic Offsets

Gun Array Offsets

Gun Configuration

Streamer Front End

Tailbuoy Offsets

Timing



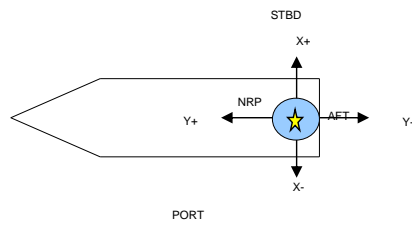
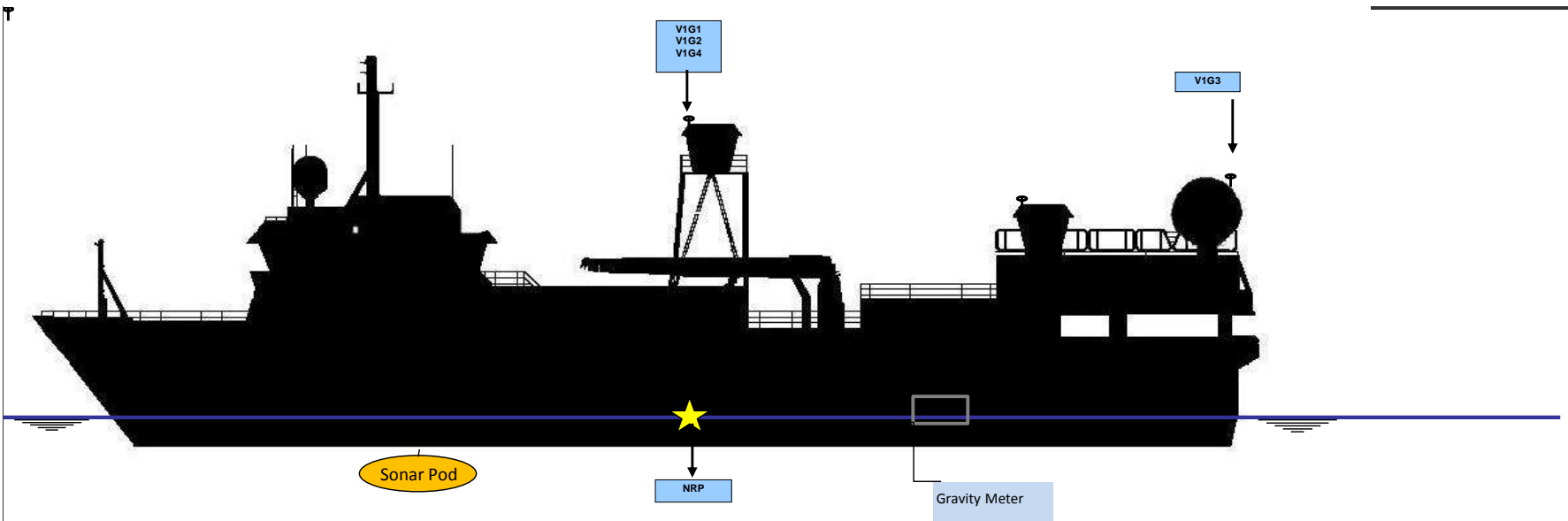

Note: All Echosounders are used in Spectra with 6.6m ship's draft correction applied.

All measurements in meters

		STBD/PORT (X)	FORE/AFT (Y)	UP/DOWN (Z)
NRP	NAVIGATION REFERENCE POINT	0.00	0.00	0.00
V1G1	C-Nav 3050	0.00	0.00	-16.90
V1G2	SeaPath 200	0.00	1.50	-16.90
V1G3	C-Nav 2000	-2.10	-29.20	-14.50
V1G4	Pos MV	-1.30	1.20	-16.90
V1R1	PosNet	-1.30	0.00	-16.90
Sonar Pod	EM122 Knudsen ADCP	0.00	20.20	7.49
MRU	Seapath MRU	2.30	-14.16	-4.30
BGM	Bell Gravity Meter	0.00	-13.10	-3.49

R/V Marcus G. Langseth - Towing Offsets

*** Offsets used for sequences ***

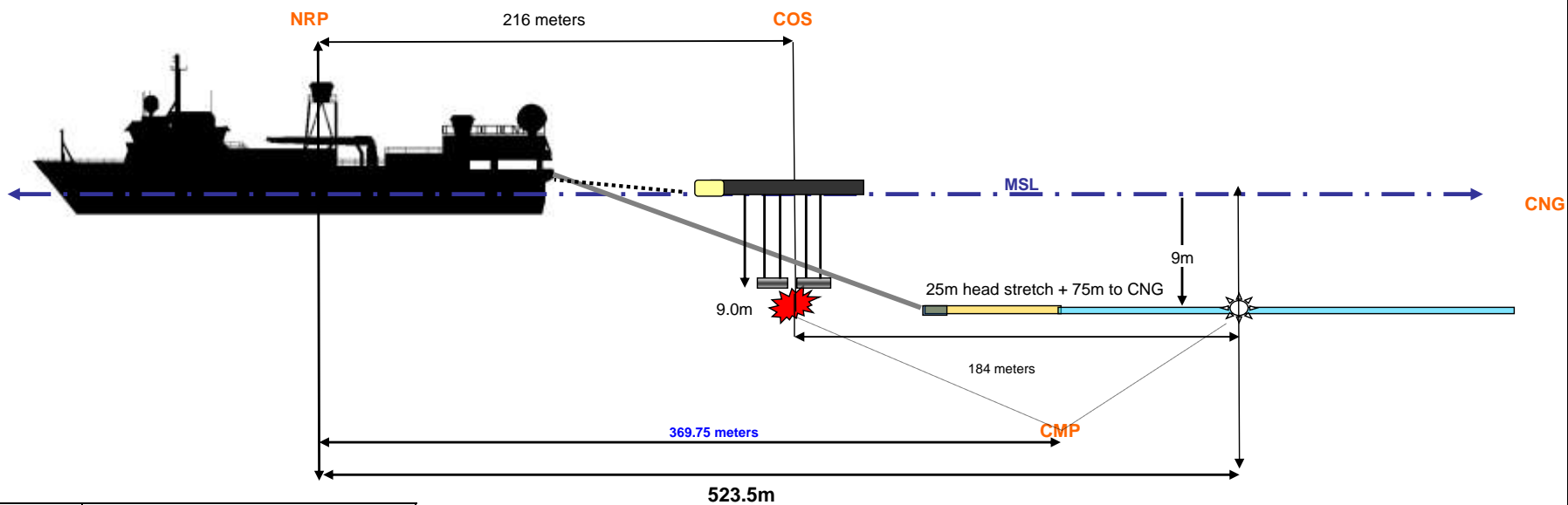

NRP	Nav Reference Point
COS	Centre of Source
CNG	Centre of Near Group (Trace # 001 of:S1)
CMP	Common Mid-Point
MSL	Mean Sea Level
NRP-Stern	29.5m
NRP-COS	216

Seq001-xxx Nominal streamer depth was

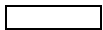

All measurements in meters

R/V Marcus Langseth
1x 7950 636 channels x 12.5m
4 Gunstrings, 6600 cubic inches

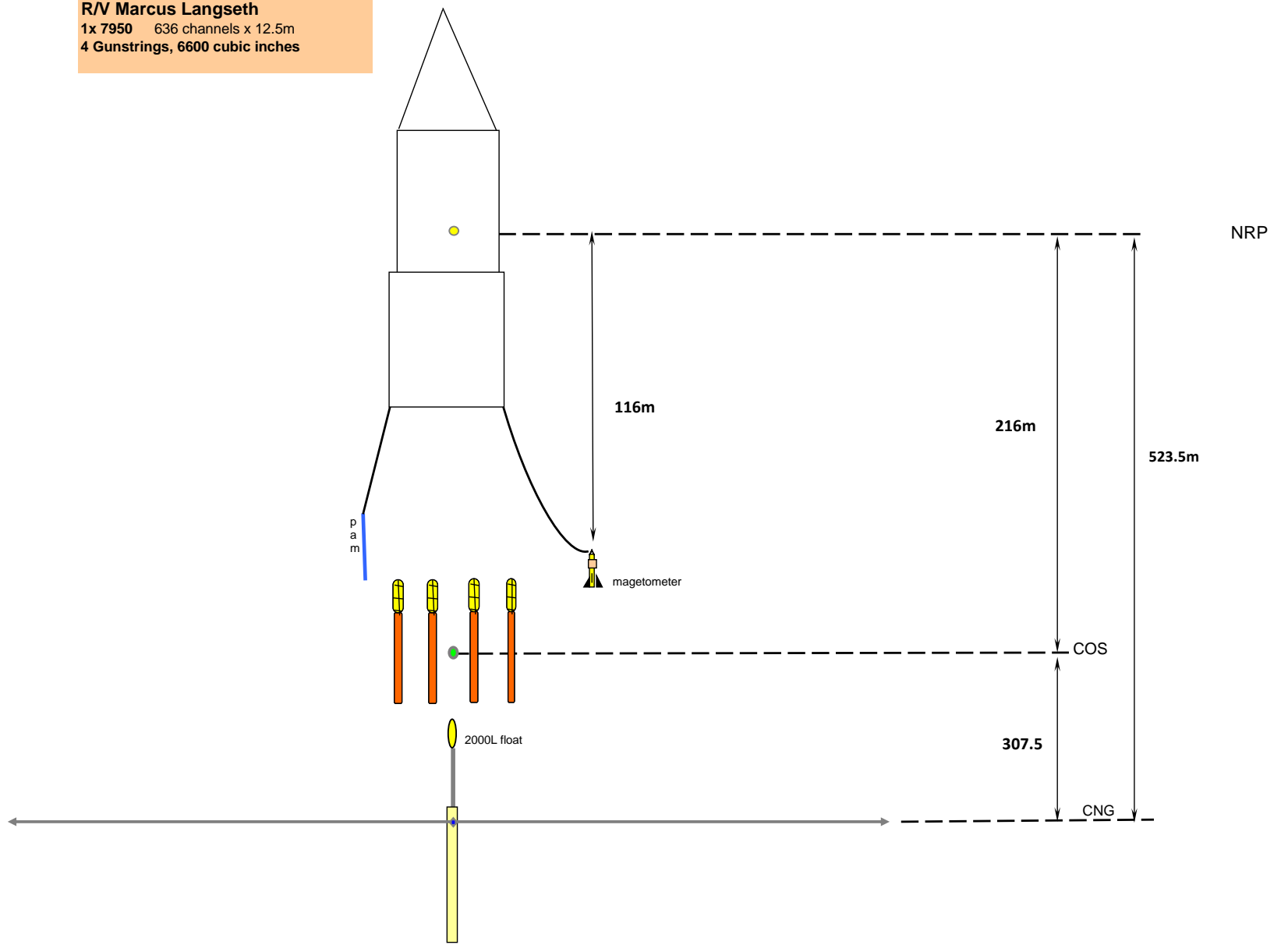

NOT to Scale

R/V Marcus G. Langseth - Acoustic Offsets

Digicourse

- Digicourse CTX Transceiver 4029
- Digicourse Streamer CMX Acoustic Transceiver
- T5 is located on the tailbuoy referenced to the rgps
- All ranges are 2-Way

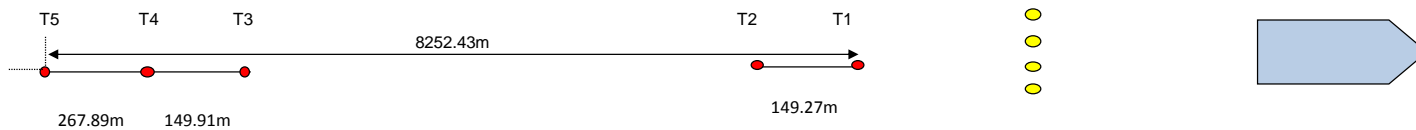

All measurements in meters

cng -> S1T1 = -37.5m
 cng -> S1T2 = -187.5m
 G1S1 -> G1T1: x = 0.0 y = -8.0m z = -11.875m
 G1S2 -> G1T2: x = 0.0 y = -8.0m z = -11.875m
 G1S3 -> G1T3: x = 0.0 y = -8.0m z = -11.875m
 G1S4 -> G1T4: x = 0.0 y = -8.0m z = -11.875m

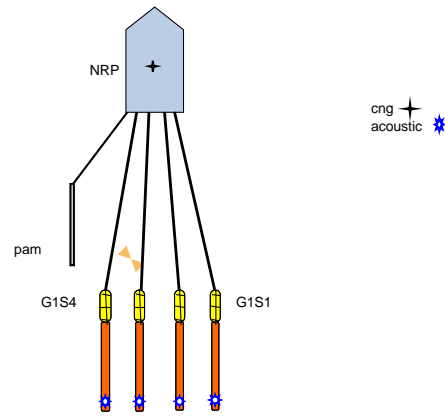

 Cable acoustic offsets are referenced to cng on individual streamer

Tailbuoy acoustics referenced to RGPS pod

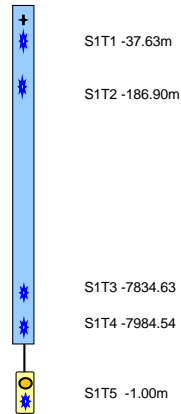

R/V Marcus G. Langseth - Gun Array Offsets

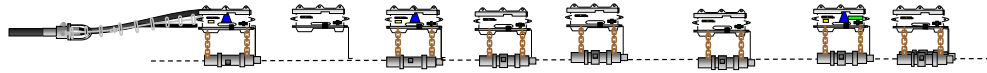
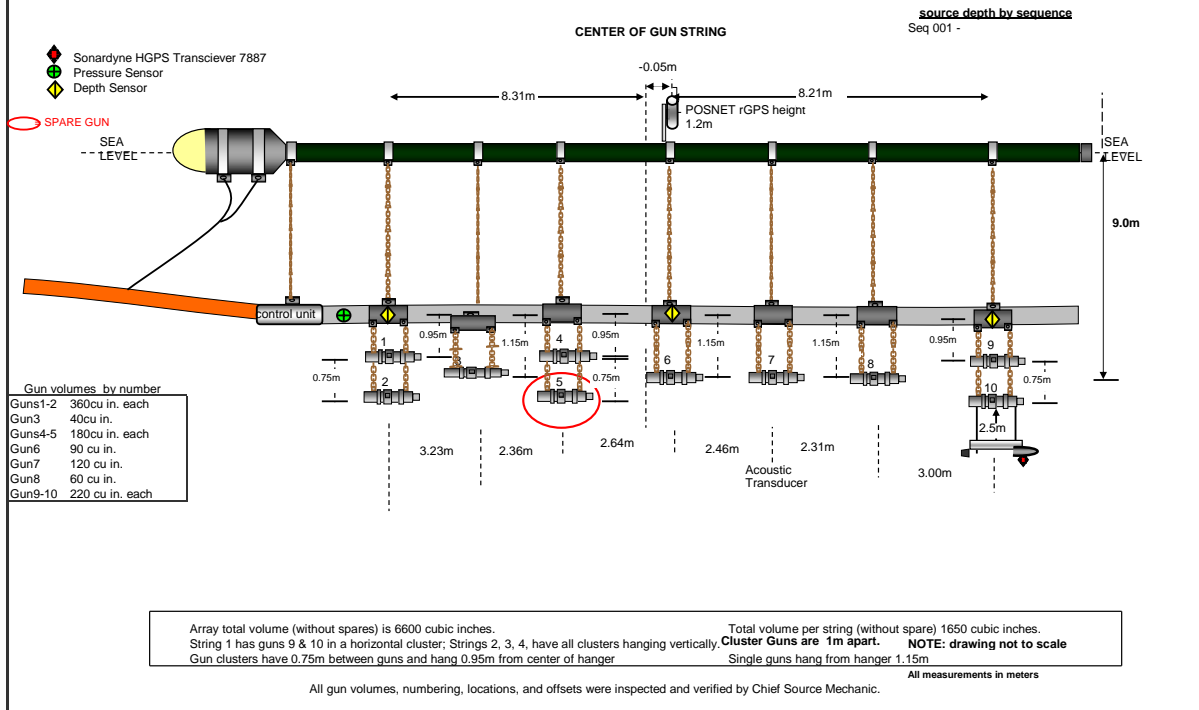

r/v Marcus G. Langseth - Gun Configuration

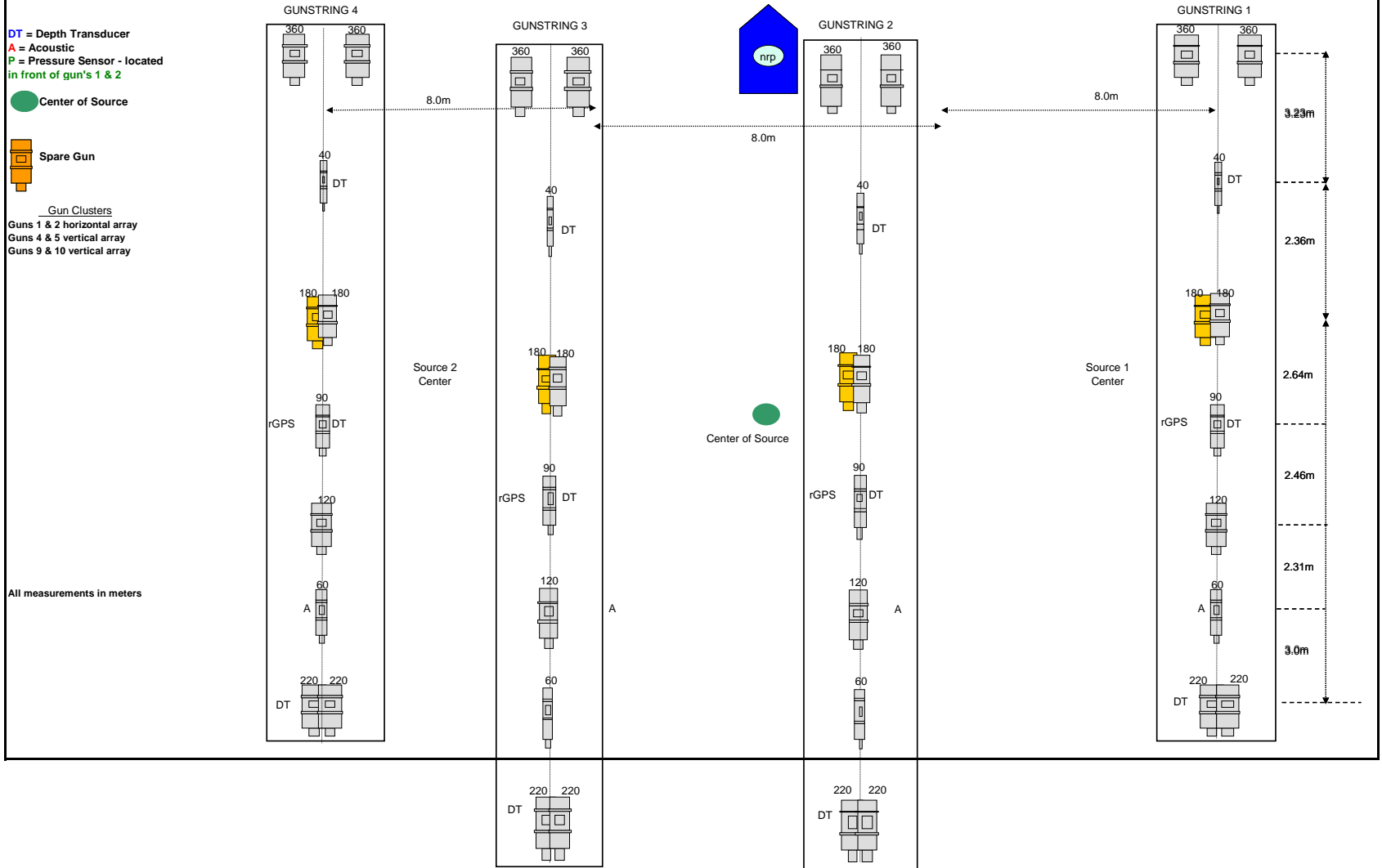

R/V Marcus G. Langseth - Streamer Front End

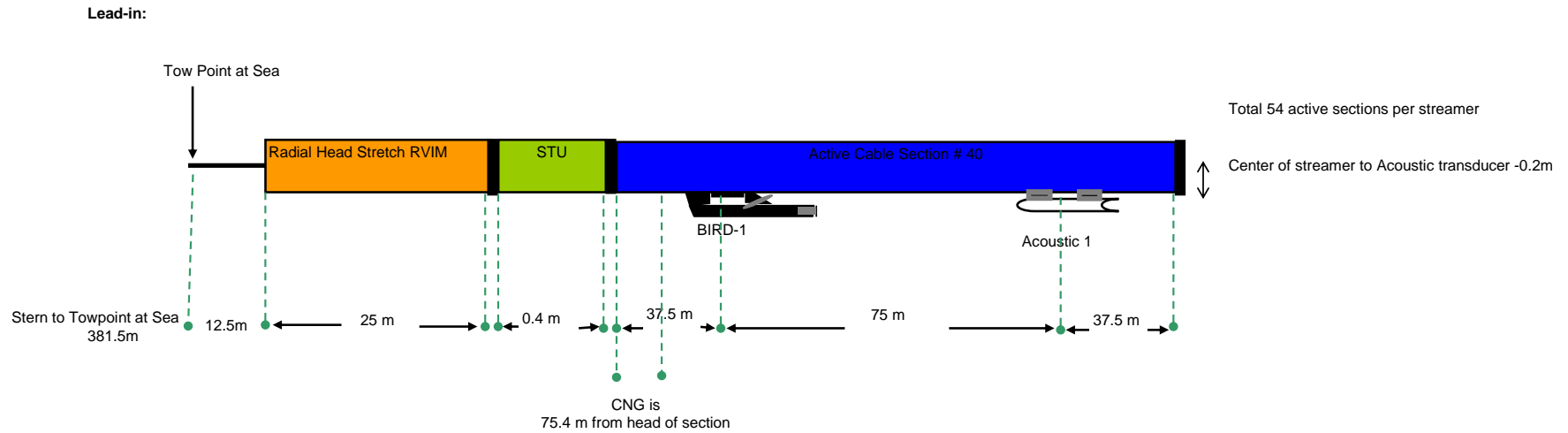

R/V Marcus G. Langseth - Tailbouy

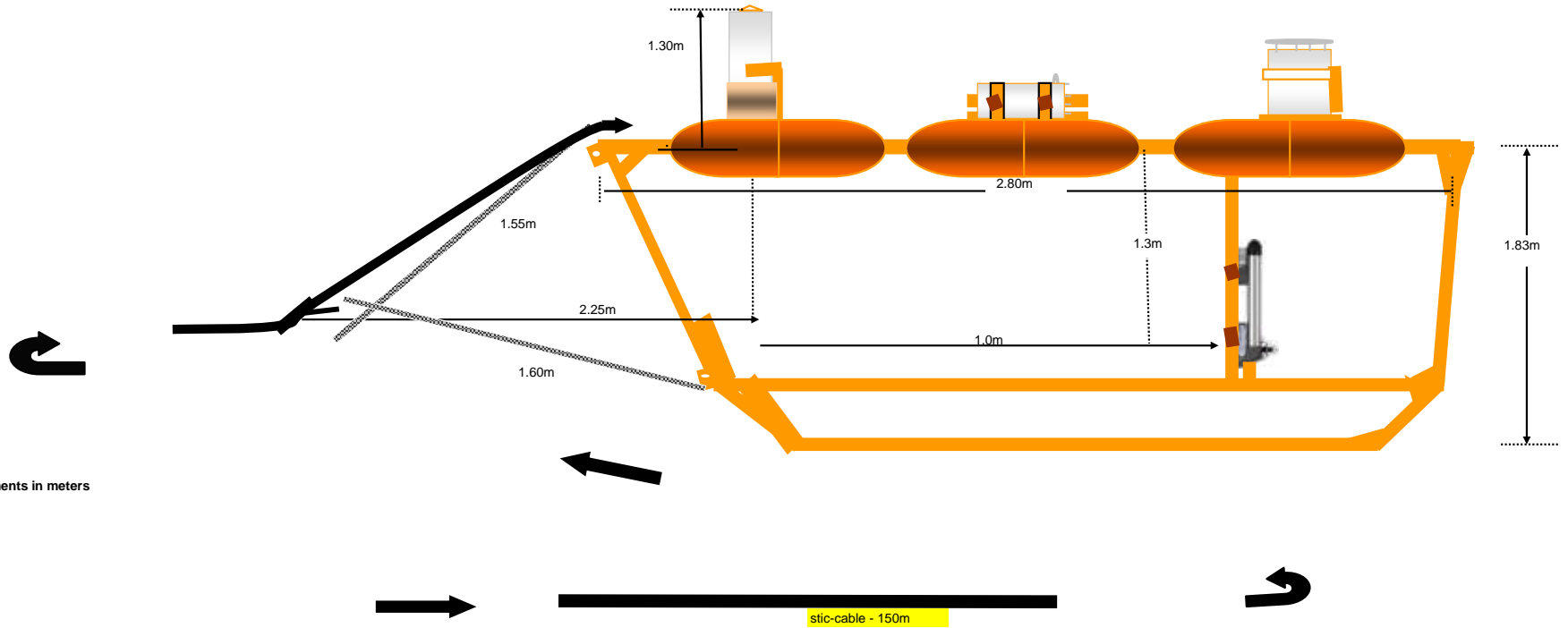

All measurements in meters

2000L Float
Circumference 1.46m

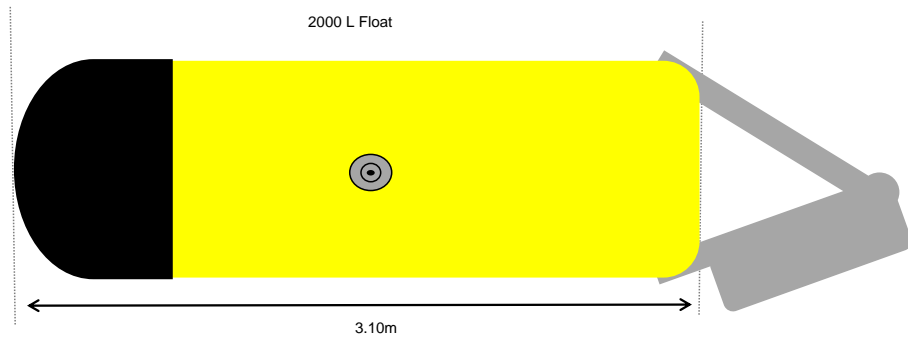

All measurements in meters

R/V Marcus G. Langseth

SPECTRA TIMING

MGL1106

Sawyer 3D

TO Shot Predict

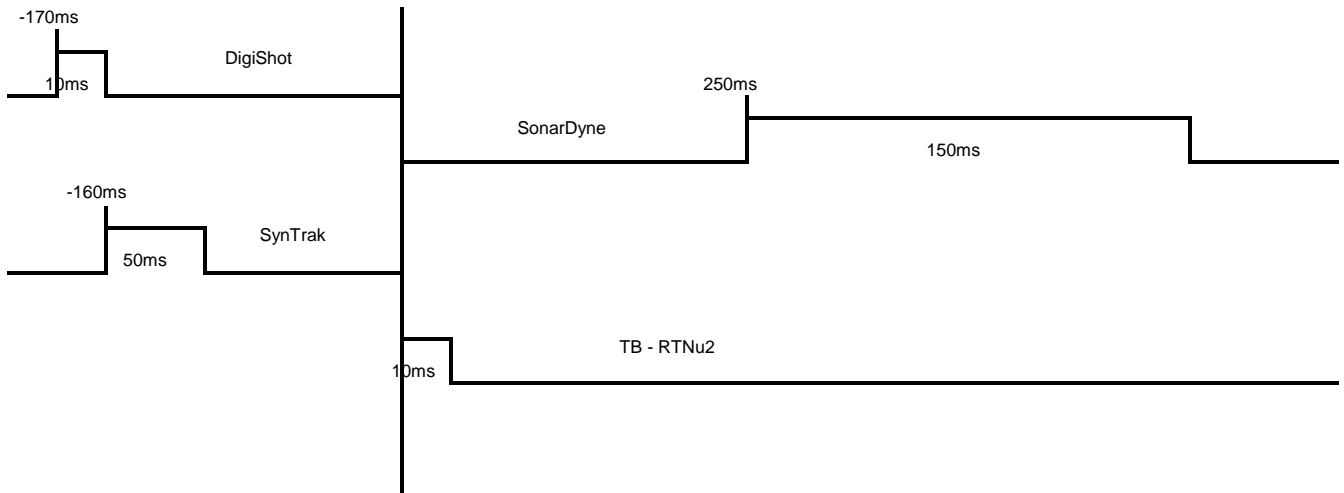

Spectra timing for r/v Marcus G. Langseth

